

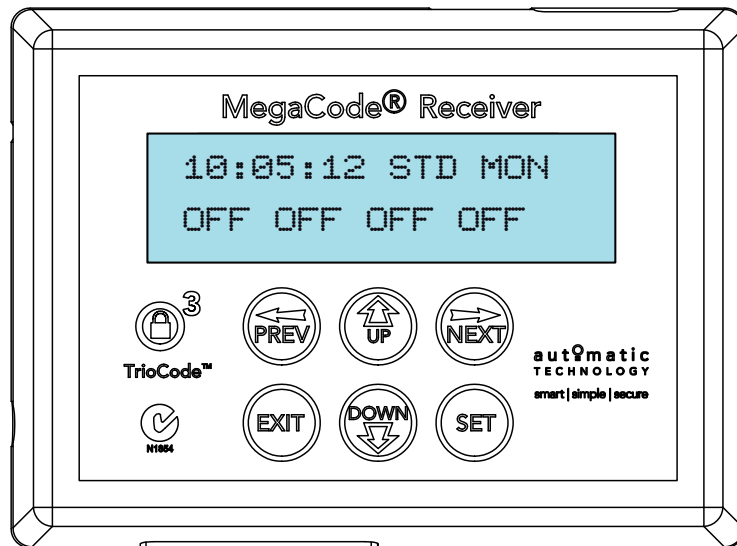

MegaCode® Receiver

Multi-Frequency Four Channel Receiver



Featuring **TrioCode™** Technology

automatic
TECHNOLOGY

smart | simple | secure



MegaCode® Receiver

Four Channel Multi-Frequency Receiver

Features	4
Operating Controls	6
Menu Structure	8
Initial Electrical Installation	9
Coding Transmitters	9
Transmitter Management	11
Code Operation (Location Empty)	12
Code Operation (Location Used)	12
Delete Operation	12
Edit Operation	12
Copy Operation	13
Remote Code Set Procedure	13
Parameter Viewing And Editing	14
Menus 2 Output One Setup	15
Menu 2.1: Output Pulse Time	15
Menu 2.2: Pulse Time Units	15
Menu 2.3: Flash On Time	15
Menu 2.4: Flash Off Time	15
Menu 2.5 Complete Flash Sequence	15
Menu 2.6: Output One Inverted	15
Menu 2.7: Trigger 1 Input	15
Menu 2.8: Trigger 1 Input Contact	15
Menu 2.9: Disable 1 Input Contact	15
Menus 3 Output Two Setup	15
Menu 3.1: Output Pulse Time	15
Menu 3.2: Pulse Time Units	15
Menu 3.3: Flash On Time	15
Menu 3.4: Flash Off Time	15
Menu 3.5 Complete Flash Sequence	15
Menu 3.6: Output Two Inverted	16
Menu 3.7: Trigger 2 Input	16
Menu 3.8: Trigger 2 Input Contact	16
Menu 3.9: Disable 2 Input Contact	16
Menus 4 Output Three Setup	16
Menu 4.1: Output Pulse Time	16
Menu 4.2: Pulse Time Units	16
Menu 4.3: Flash On Time	16
Menu 4.4: Flash Off Time	16
Menu 4.5 Complete Flash Sequence	16
Menu 4.6: Output Three Inverted	16
Menu 4.7: Trigger 3 Input	16
Menu 4.8: Trigger 3 Input Contact	16
Menu 4.9: Disable 3 Input Contact	16
Menus 5 Output Four Setup	17





Menu 5.1: Output Pulse Time	17
Menu 5.2: Pulse Time Units	17
Menu 5.3: Flash On Time	17
Menu 5.4: Flash Off Time	17
Menu 5.5 Complete Flash Sequence	17
Menu 5.6: Output Four Inverted	17
Menu 5.7: Trigger 4 Input	17
Menu 5.8: Trigger 4 Input Contact	17
Menu 5.9: Disable 4 Input Contact	17
Menu 6 Operating Modes	17
Menu 6.1: Default Tx Button 1 Function	17
Menu 6.2: Default Tx Button 2 Function	17
Menu 6.3: Default Tx Button 3 Function	17
Menu 6.4: Default Tx Button 4 Function	17
Menu 6.5: Remote Code	17
Menu 6.6: Activity Report	17
Menu 6.7: Activity Report ID	17
Menu 6.8: Vacation	17
Menu 6.9: Password Protection	18
Menu 6.10: Tx# Grouping	18
Menu 7 Time Clock	18
Time Clock Operation	18
Time Clock Settings	18
Menu 7.1 Set Time/date	18
Menu 7.2 View Programs	18
Menu 7.3 Settings	19
Menu 7.3.1 Run Programs	19
Menu 7.3.2 Disable 4 Input	19
Menu 7.3.3 Disable 4 Input Contact	19
Menu 7.3.4 Daylight Saving Time Adjust	19
Menu 8 Diagnostics Tools	19
Menu 8.1 Test Inputs	19
Menu 8.2 Test Tx'ers	19
Menu 8.3 Display History	20
Menu 8.4 Memory Usage	20
Menu 8.5 Console Test	20
Menu 9 Memory Tools	20
Menu 9.1 Clr Control	20
Menu 9.2 Clr Tx'ers	20
System Specifications	21
Warranty	22





Features

Thank you for purchasing the Automatic Technology MegaCode® Receiver. Designed by our renowned engineers to suit garage doors and gate openers, the MegaCode® Receiver will provide years of smart, simple & secure convenience to your home.

Multiple Modes Of Control

The solid state relay outputs of the MegaCode® receiver can be controlled by remote control transmitters, wired inputs and a programmable time clock. Each output can be configured to be a steady state or flashing output

TrioCode™ Code Hopping Technology

Every time a TrioCode™ transmitter is used, a new security code is randomly generated from over 4.29 billion possibilities. This greatly enhances the security of the system and makes "code grabbing" a thing of the past.

These transmitters also overcome interference issues by simultaneously sending a signal over three slightly different frequencies. Even if two of the three signals are jammed, the system will still work.

Programmable Time Clock

The Time Clock can be used to override transmitter and trigger input control at various times of the day on a weekly basis. An output can be forced on, forced off or released for transmitter or trigger input control. The Time Clock has 32 programs which select the output to be controlled and the time and days of the week it is to be activated.

Console

Incorporated into the MegaCode® receiver is a simple to use console which consists of several buttons and a display. With the addition of the console, facilities which were only available on previous receivers using an additional hand held programmer are now available as standard via a simple menu system. Features include editing transmitter storage and names, setting various parameters, and performing system diagnostics.

Security Code Store

The MegaCode® receiver uses state of the art technology in storing your selected transmitter security codes. Up to 511 different transmitters can be stored in the memory with the facility to assign an 11 character ID label to each transmitter.





Transmitter Management Flexibility

Whenever a large number of transmitters are used, managing those transmitter effectively is of great importance. The MegaCode® receiver provides many features which enhance transmitter management. Transmitters can be listed by store location, group number, serial number or I.D label. Tools are available which allow transmitters to be Replaced, Deleted and Edited. A quick transmitter code set feature is provided which allows the button functions of an existing transmitter to be copied to all transmitters to be coded. This feature allows many transmitters to be coded without the need for the installer to touch any console buttons during the coding process.

Status Indication

The status of the receiver outputs and the last event are displayed whenever the main screen is shown. Information provided includes; the status of each output, the last transmitter or input that was activated, the last output affected, the time remaining before an output timer expires etc.

Password Protection

All operating parameters and transmitter storage can be protected from being changed by unauthorised personnel by an optional password protection feature.

Vacation mode

A handheld transmitter can be programmed to lock and unlock all other transmitters that have been programmed into the openers' memory. The vacation mode can be used when the door is left idle for long periods of time.





Operating Controls

- 01 02 **AC/DC Power Supply Input** 12 to 24 AC/DC power supply input terminal.
- 03 04 **Output One (1)** normally open contacts of the solid state relay output can be controlled by remote control transmitters, wired inputs and a programmable time clock.
- 05 06 **Output Two (2)** normally open contacts of the solid state relay output can be controlled by remote control transmitters, wired inputs and a programmable time clock.
- 07 08 **Output Three (3)** normally open contacts of the solid state relay output can be controlled by remote control transmitters, wired inputs and a programmable time clock.
- 09 10 **Output Four (4)** normally open contacts of the solid state relay output can be controlled by remote control transmitters, wired inputs and a programmable time clock.
- 11 12 **Trigger Input One (1)** the output one (1) can also be controlled via trigger one (1) independently. The trigger input can be programmed to activate its output similar to a transmitter button.
- 13 14 **Trigger Input Two (2)** the output two (2) can also be controlled via trigger two (2) independently. The trigger input can be programmed to activate its output similar to a transmitter button.
- 15 16 **Trigger Input Three (3)** the output three (3) can also be controlled via trigger three (3) independently. The trigger input can be programmed to activate its output similar to a transmitter button.
- 17 18 **Trigger Input Four (4)** the output four (4) can also be controlled via trigger four (4) independently. The trigger input can be programmed to activate its output similar to a transmitter button.
- 19 20 **Disable Input One (1)** activation of this input will disable Output One (1)
- 21 22 **Disable Input Two (2)** activation of this input will disable Output Two (2)
- 23 24 **Disable Input Three (3)** activation of this input will disable Output Three (3)
- 25 26 **Disable Input Four (4)** activation of this input will disable Output Four (4)
- 27 **AC/DC Power Supply plug pack Input** 12 to 24 AC/DC power supply input
- 28 **Antenna connector**
- 29 **Clock Battery**
- 30 **Prog Input** is used to connect the Automatic Technology Handheld Programmer for editing control and receiver functions, accessing diagnostic tools, and activating special features and operating modes.



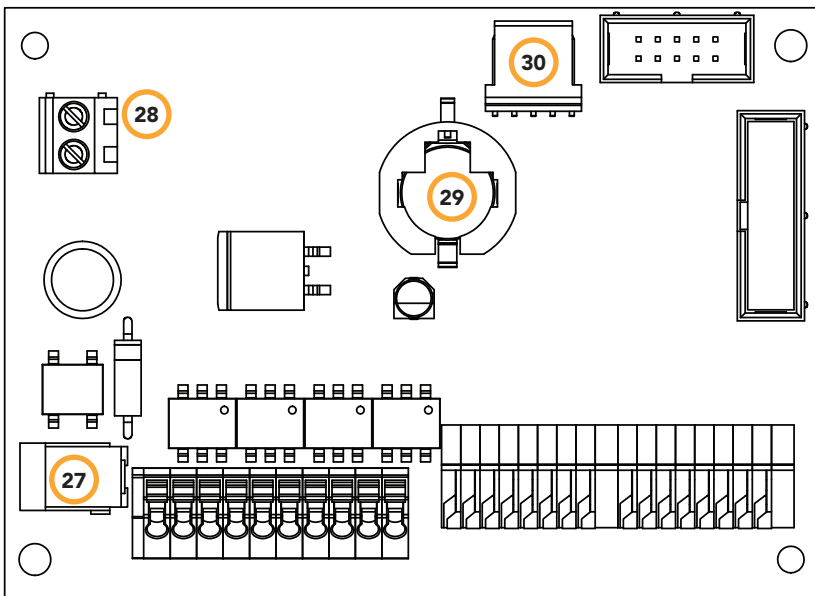
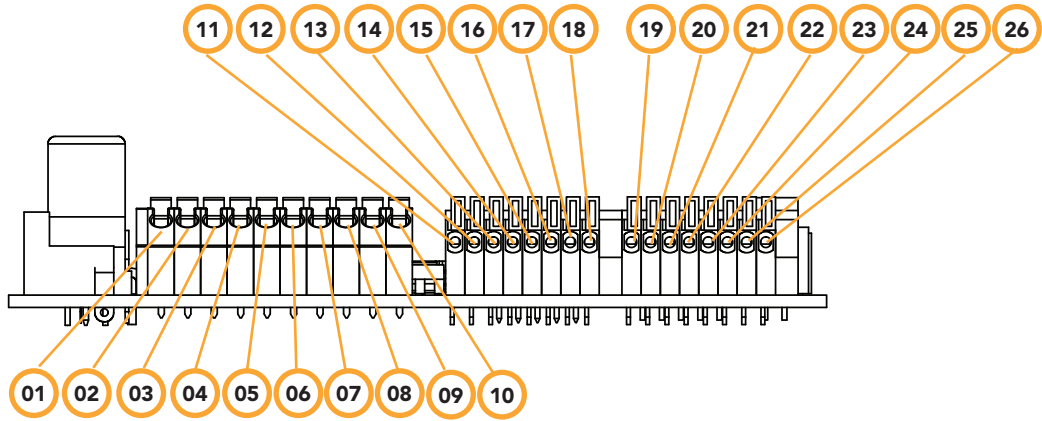



Menu Structure

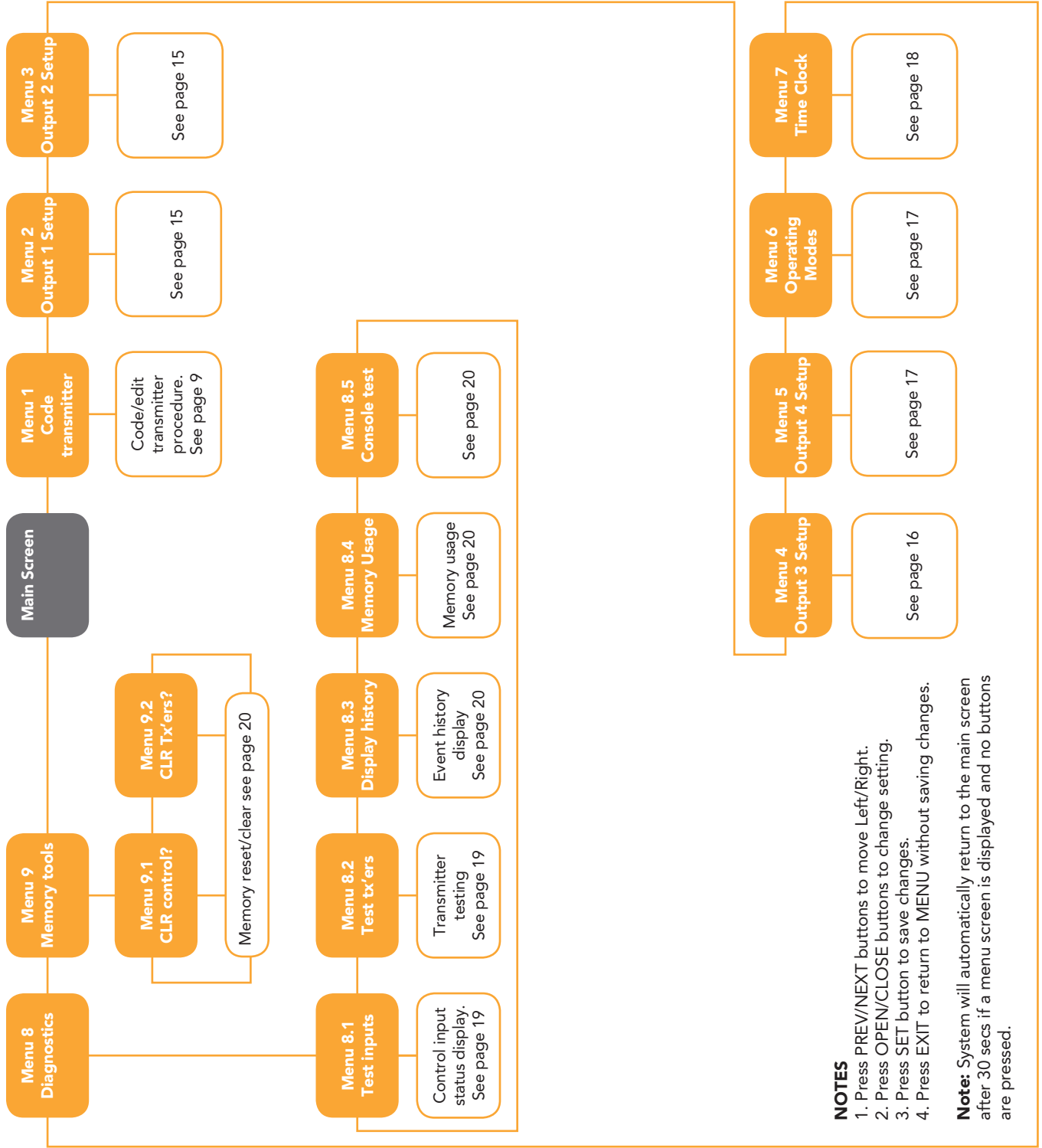

NOTES

1. Press PREV/NEXT buttons to move Left/Right.
2. Press OPEN/CLOSE buttons to change setting.
3. Press SET button to save changes.
4. Press EXIT to return to MENU without saving changes.

Note: System will automatically return to the main screen after 30 secs if a menu screen is displayed and no buttons are pressed.





Initial Electrical Installation

Receiver Supply

The MegaCode® receiver is designed to be powered from 12V - 24VAC/DC. A suitable 12VDC plug pack also can be used to power up the MegaCode® receiver.

Wiring Outputs

Each output is able to switch up to 40VAC/DC @ 100mA. Each output consists of a solid state relay with normally open (selectable to N/C) contacts. No internal connections exist to the relay contacts so it may be treated as a simple switch.

Wiring Inputs And Powering Up The Receiver

Each input is operated by a simple switch contact. Do not apply any voltage to the inputs. The Trigger inputs are normally open (selectable to N/C) inputs. After re-checking all wiring, apply power to the receiver. The receiver will go through a startup sequence displaying the startup screen which indicates the receiver type and firmware version (**Fig. 1**). After a short delay the main screen will be displayed. This will show the current time and day of the week on the top line. The bottom line will show the output status starting with Output 1 on the left through to Output 4 on the right (**Fig. 2**). Make sure the time and day are set correctly.

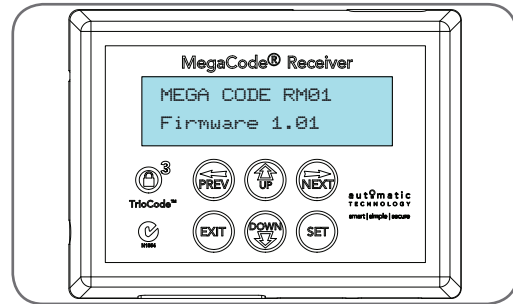

fig 1

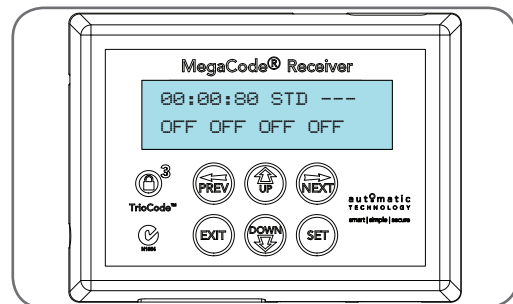

fig 2

Coding Transmitters

The MegaCode® receiver can store up to five hundred and eleven (511) transmitters in its memory. Each transmitter can be allocated an alpha-numeric ID label up to eleven (11) characters in length and each button can be assigned to any channel. The settings for a transmitter are represented in (**Fig. 3**). It shows the transmitter's store number, ID label or serial number and the functions assigned to each of its four buttons. To toggle between ID/SN display, press UP/DOWN with the cursor on the ID/SN indicator.

Brand Of Transmitters

The first memory location sets the type of transmitters which can be stored into the memory of the receiver. It either can be Automatic Technology TrioCode™ or B&D Tri-Tran™ transmitters. For example, if the first transmitter stored is TrioCode™, then the rest of the transmitters can only be the TrioCode™ type and mixing of TrioCode™, Tri-Tran™ is not possible. The deletion of all stored transmitter codes from the receivers memory will allow you to choose either TrioCode™ or Tri-Tran™ transmitters again.

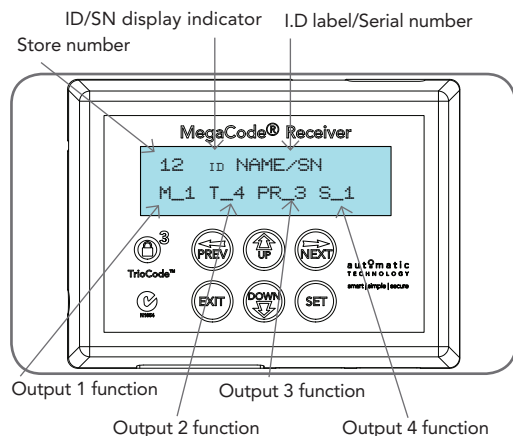

fig 3





Coding Transmitters

fig 4

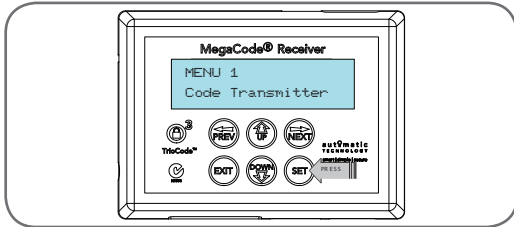

Any button of the transmitter can be assigned to any output on the MegaCode® receiver. To code a transmitter button:

Navigating to "Code Transmitter" menu

1. Press NEXT to navigate to the Menu 1 (Fig. 4).
2. Press SET to enter code set procedure.

Storing transmitter code

1. Receiver will prompt to press one of the transmitter's buttons.
2. Press the transmitter button you wish to operate the receiver (e.g. button 1) (Fig. 5).
3. Press the same transmitter button again as prompted by display (Fig. 6).

fig 5

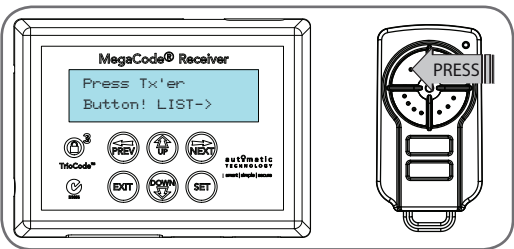

Selecting function of the button

The receiver will now show the transmitter's record, with a cursor on the field for the button being coded (Fig. 7). Use UP/DOWN to select the function for the button.

fig 6

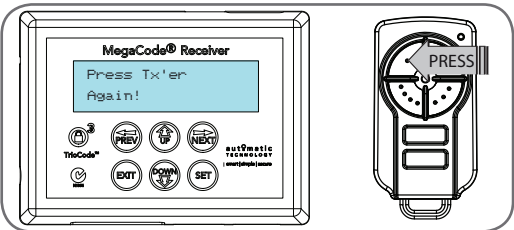

Available functions are:

- M_# (Mimic)
- P_# (Pulse)
- PR# (Pulse/Reset)
- T_# (Toggle)
- S_# (Set)
- R_# (Reset)
- VAC (Vacation)
- (OFF)

fig 7

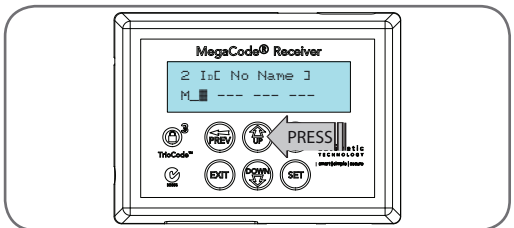

Where # is the output Number 1,2,3,4

Press SET to save the settings (Fig. 8) or EXIT to abort without saving.

Editing the store location

This feature is only available when coding the first button of a new transmitter.

1. Press NEXT or PREV to move cursor over Store No.
2. Press UP or DOWN to select new Store No (Fig. 9).
3. Press SET to Confirm or NEXT/PREV to move to next field.

fig 8

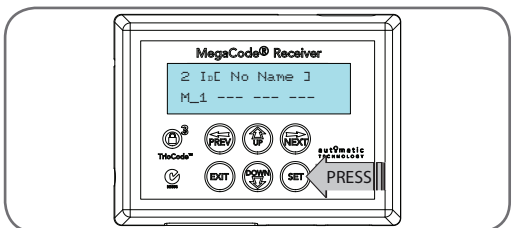

This is useful when managing transmitters using a scheme which ties the store location to the transmitter's owner.

fig 9

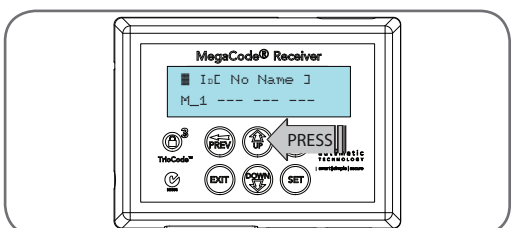

Returning to main screen

The "Code Transmitter" menu will now be shown. Press EXIT to return to the main screen and test the transmitter.





Transmitter Management

The MegaCode® provides a transmitter listing facility which enables the User to find a transmitter location within memory. Once located a stored transmitter can be replaced, deleted, edited, copied or, if the location is empty, a new transmitter can be coded.

Method 1 - Go to the start of the list Accessing the list menu

1. Press NEXT to navigate to Menu 1.
2. Press SET to enter the transmitter edit procedure (Fig. 10).
3. Press NEXT to enter the transmitter list and edit mode (Fig. 11). This is used if the transmitter is not available.

Method 2 - Use transmitter to go direct to list Accessing the list menu

1. Press NEXT to navigate to Menu 1.
2. Press SET to enter the transmitter edit procedure (Fig. 10).
3. Press transmitter once (Fig. 12).
4. Press NEXT to view transmitter parameters (Fig. 13). This is used for quick navigation if the transmitter is available. The transmitter details will be shown (Fig. 14).

NOTE: "VIEW>" will not be shown if the transmitter is not stored.

Once the list is displayed it can be sorted by stored number, ID Label or Serial Number. Use NEXT or PREV button to select sorting method.

NOTE: When sorting by ID label or S/N, only stored transmitter locations are displayed.

Navigating the list

1. Press UP or DOWN buttons to navigate through the list (Fig. 15).
2. Press SET to display menu of available functions.

NOTE: Holding a button down will step through the list faster.

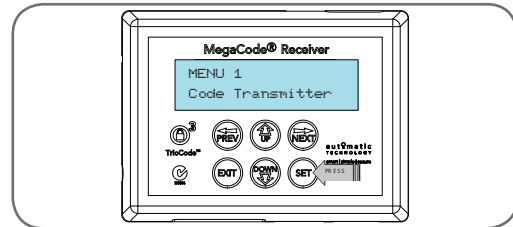

fig 10

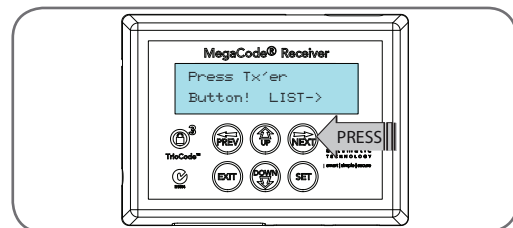

fig 11



fig 12

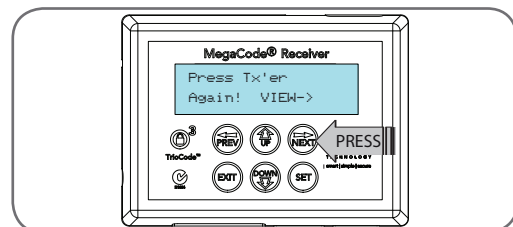

fig 13

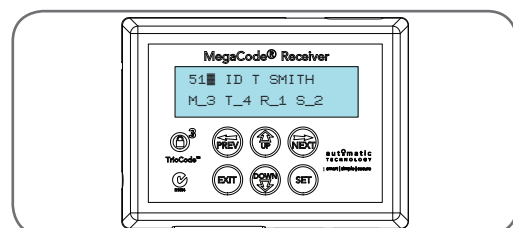

fig 14

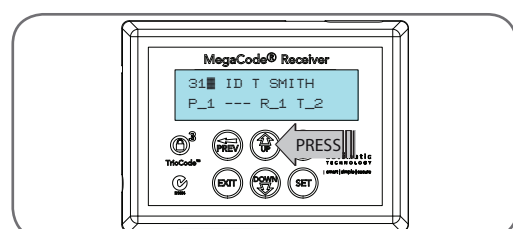

fig 15





Transmitter Management

fig 16

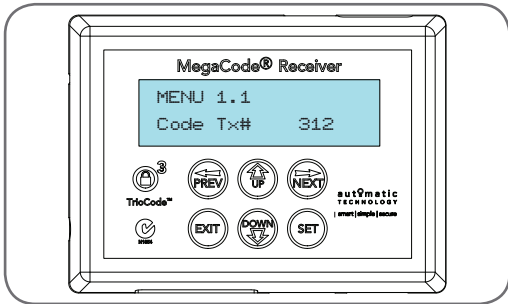

Selecting an Operation

Press NEXT or PREV to cycle through the four menu options (Fig. 16-19). Press EXIT to return to the list. Press SET to execute the menu's operation.

Menu 1.1 Code Operation (location empty)

If the code operation is selected on an empty transmitter location, the code transmitter procedure will be initiated with the transmitter being saved in the selected location. This is useful when managing transmitters using a scheme which ties the store location to the transmitter's owner.

fig 17

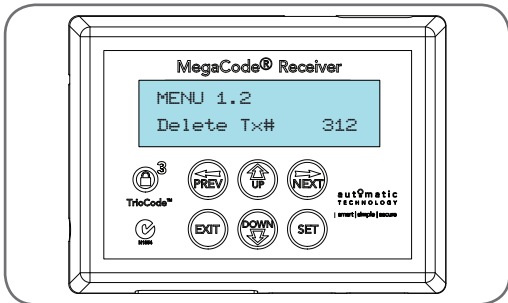

Menu 1.1 Code Operation (location used)

If the code operation is selected for a location that already contains a transmitter, then the code transmitter procedure will be initiated and the new transmitter will replace the existing one. Note that the button functions and name of the existing transmitter will be transferred to the new transmitter. This procedure is of great convenience when replacing a lost transmitter.

Menu 1.2 Delete Operation

The delete operation is used to remove a transmitter from memory along with the name and button function settings.

fig 18

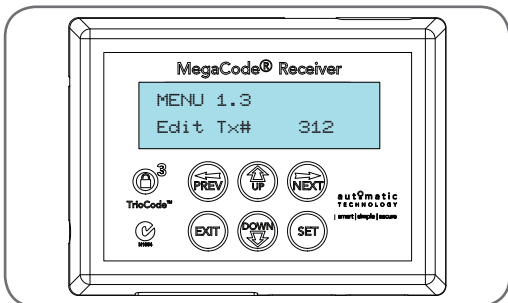

Menu 1.3 Edit Operation

The edit operation displays the transmitter record for editing purposes.

Editing The Button Function Fields

- Select the desired field by using NEXT or PREV to move the cursor.
- Use UP and DOWN to change the displayed value. When the correct setting has been made repeat step i (above) to select the next field to edit. The example (Fig. 19) shows editing the function of transmitter number 510 assigned to the Output 1.

fig 19

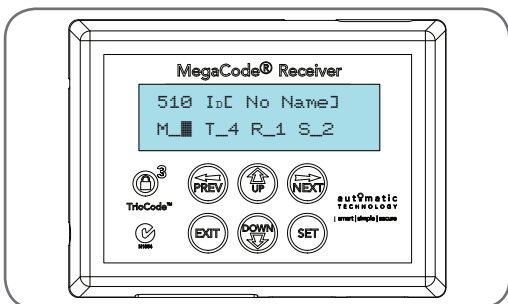

Available functions:

- M_# (Mimic)
- P_# (Pulse)
- PR# (Pulse/Reset)
- T_# (Toggle)
- S_# (Set)
- R_# (Reset)
- VAC (Vacation)
- (OFF)

Where # is the output number M_1,M_2, M_3,M_4 Press SET to save the settings (Fig. 8) or EXIT to abort without saving.





Editing A Character Field

- i. Select the desired field by using NEXT or PREV to move the cursor.
- ii. Use UP and DOWN to change the displayed value. When the correct setting has been made repeat step i (above) to select the next field to edit. The example (Fig. 20) shows editing the function of transmitter number 510 assigned to the Output 1. When a change is made, the bottom line of the display will show a list of available characters to choose from with the current value indicated at the cursor position (Fig. 20). When the correct character has been selected, repeat STEP 2 to select the next field to edit.

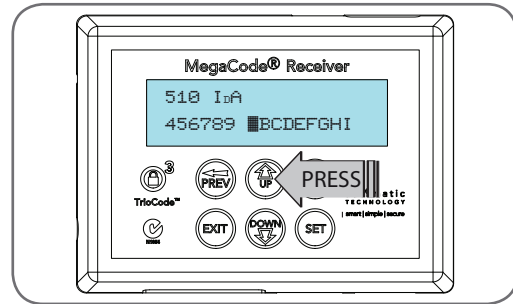

fig 20

Menu 1.4 Copy Operation

The copy operation is used to code multiple transmitters with the same button function as that of the selected transmitter.

Exiting The List

To exit the transmitter list simply press EXIT to return to the code.

Remote Code Set Procedure

If a TrioCode™ transmitter is already coded into the MegaCode® receiver, additional TrioCode™ transmitters can be coded without being in direct contact with the MegaCode® receiver.

NOTE: Only the function of the existing transmitter button can be assigned to new transmitter. Take into account that there is a time-out facility for security reasons. This feature is only available with TrioCode™ transmitters

1. Selecting the function to be coded

Using the existing transmitter, operate the MegaCode® receiver's output with the transmitter button which has the function to be coded (Fig. 21) (e.g. Button 1 has been coded with the M_1 function assigned).

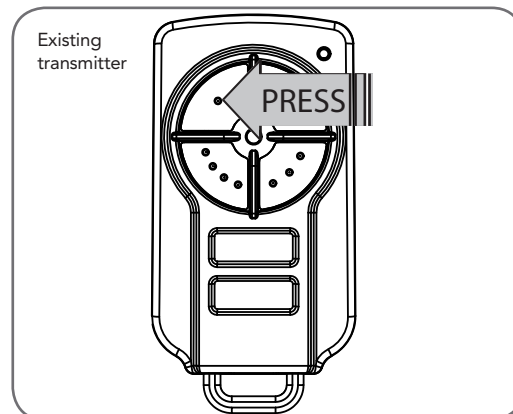

fig 21

3. Activate remote code set mode

Using a small pin, press and hold through the Coding Hole of the existing transmitter for two seconds (Fig. 22).

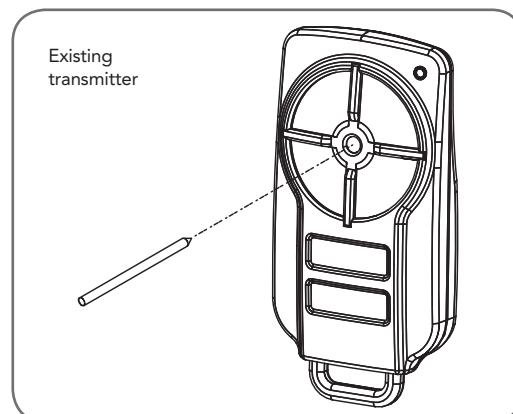

fig 22

4. Code new transmitter button

Within 10 seconds, press the button on the new transmitter you wish to code for 2 seconds (Fig. 23).

5. Confirm transmitter button to be coded

Press the same button again (within 10 seconds) for confirmation.





Remote Code Set Procedure

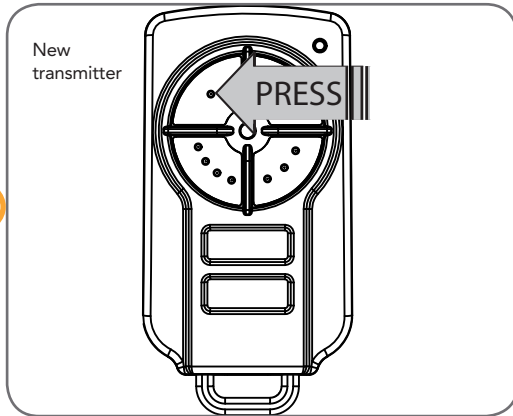

fig 23

6. Test operation

The new transmitter button should now function identically to the existing transmitter.

NOTE: When a transmitter is remote coded, its ID label is set to that of the existing transmitter. If the existing transmitter does not have an ID label assigned, then the ID label of the new transmitter is set to: R/C Tx ###, where ### is the existing transmitters store number. This ensures that the originator of any remote coded transmitter can be identified.

Viewing And Editing Parameters

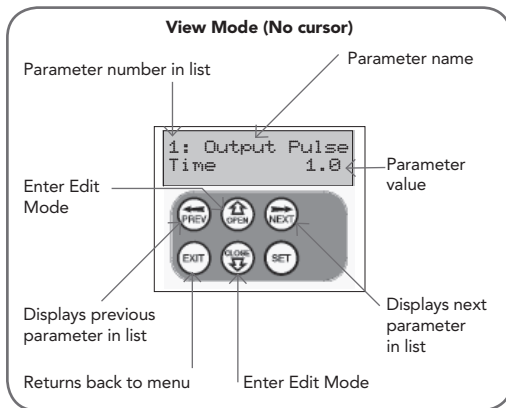

fig 24

This section illustrates how to locate, view and adjust parameters.

Locating parameters

Refer to MENU STRUCTURE on Page 8. Locate the required parameter and note the MENU number. The example used in (Fig. 24) displays "1: Output Pulse Time"

Changing setting

1. Press NEXT/PREV to navigate to the required menu.
2. Press SET to show the sub-menu.
3. Press NEXT/PREV to go to required sub-menu.
4. Press SET to enter edit mode.
5. Press UP/DOWN to change the parameter setting (Fig. 25). Holding the button down causes the parameter's value to change rapidly. The longer the button is held, the faster the value changes.
6. Press SET to SAVE setting.

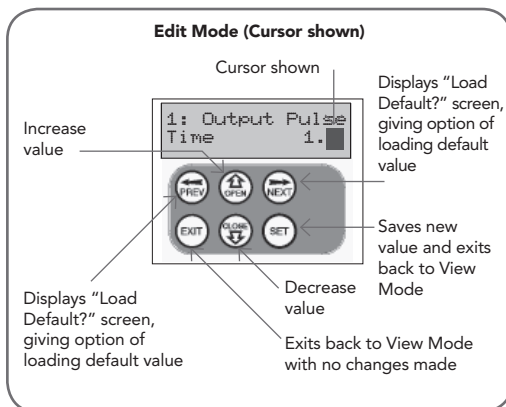

fig 25

Reload default Value

1. Press NEXT/PREV buttons to display LOAD DEFAULT screen.
2. Press SET to load the default value.

Return to menu

If the parameter's value is not to be changed, press EXIT to return to the sub menu. Press EXIT again to return to the MAIN SCREEN.





Menu 2 Output One Setup

Menu 2. Output One Setup

The output setup parameters in Menu 2 is used to configure Output One.

Menu 2.1: Output Pulse Time

This parameter sets the duration of the output pulse time. The output pulse time is used only for pulse functions. The time is adjustable from 0.1 to 99.9 units.

Menu 2.2: Pulse Time Units

This parameter sets the units used for the output time settings. The options are Sec, Min or Hrs.

Menu 2.3: Flash On Time & Menu 2.4: Flash Off Time

A flash on an output is created by repeatedly turning the output on and off. The Flash On Time sets the duration of the on phase while the Flash Off Time sets the duration of the off phase. For a steady output state which does not flash, set the Flash On Time = 0.0s. The Flash Off Time is not used for steady state outputs.

Menu 2.5: Complete Flash Sequence

Turning this parameter on will allow the flash cycle to complete if the output is turned off during the flash cycle.

Menu 2.6: Output One Inverted

Output One is configured for N/O operation. This parameter allows its operation to be changed to N/C.

Menu 2.7: Trigger One Input

Output One can also be controlled via independent Trigger One input. The trigger input can be programmed to activate its output similar to a transmitter button.

Menu 2.8: Trigger One Input Contact

Trigger One input is configured for N/O operation. This parameter allows its operation to be changed to N/C.

Menu 2.9: Disable One Input Contact

This input can be used to disable the output in software regardless of the state of the transmitters, wired inputs or time clock. The disable input is normally configured for N/O operation. This parameter allows its operation to be changed to N/C.

Menu 3 Output Two Setup

Menu 3. Output Two Setup

The output setup parameters in Menu 3 is used to configure Output Two.

Menu 3.1: Output Pulse Time

This parameter sets the duration of the output pulse time. The output pulse time is used only for pulse functions. The time is adjustable from 0.1 to 99.9 units.

Menu 3.2: Pulse Time Units

This parameter sets the units used for the output time settings. The options are Sec, Min or Hrs.

Menu 3.3: Flash On Time & Menu 3.4: Flash Off Time

A flash on an output is created by repeatedly turning the output on and off. The Flash On Time sets the duration of the on phase while the Flash Off Time sets the duration of the off phase. For a steady output state which does not flash, set the Flash On Time = 0.0s. The Flash Off Time is not used for steady state outputs.

Menu 3.5: Complete Flash Sequence

Turning this parameter on will allow the flash cycle to complete if the output is turned off during the flash cycle.





Menu 3.6: Output Two Inverted

Output Two is configured for N/O operation. This parameter allows its operation to be changed to N/C.

Menu 3.7: Trigger Two Input

Output Two can also be controlled via independent Trigger One input. The trigger input can be programmed to activate its output similar to a transmitter button.

Menu 3.8: Trigger Two Input Contact

Trigger Two input is configured for N/O operation. This parameter allows its operation to be changed to N/C.

Menu 3.9: Disable Two Input Contact

This input can be used to disable the output in software regardless of the state of the transmitters, wired inputs or time clock. The disable input is normally configured for N/O operation. This parameter allows its operation to be changed to N/C.

Menu 4 Output Three Setup

Menu 4. Output Three Setup

The output setup parameters in Menu 4 is used to configure Output Three.

Menu 4.1: Output Pulse Time

This parameter sets the duration of the output pulse time. The output pulse time is used only for pulse functions. The time is adjustable from 0.1 to 99.9 units.

Menu 4.2: Pulse Time Units

This parameter sets the units used for the output time settings. The options are Sec, Min or Hrs.

Menu 4.3: Flash On Time & Menu 3.4: Flash Off Time

A flash on an output is created by repeatedly turning the output on and off. The Flash On Time sets the duration of the on phase while the Flash Off Time sets the duration of the off phase. For a steady output state which does not flash, set the Flash On Time = 0.0s. The Flash Off Time is not used for steady state outputs.

Menu 4.5: Complete Flash Sequence

Turning this parameter on will allow the flash cycle to complete if the output is turned off during the flash cycle.

Menu 4.6: Output Three Inverted

Output Three is configured for N/O operation. This parameter allows its operation to be changed to N/C.

Menu 4.7: Trigger Three Input

Output Three can also be controlled via independent Trigger Three input. The trigger input can be programmed to activate its output similar to a transmitter button.

Menu 4.8: Trigger Three Input Contact

Trigger Three input is configured for N/O operation. This parameter allows its operation to be changed to N/C.

Menu 4.9: Disable Three Input Contact

This input can be used to disable the output in software regardless of the state of the transmitters, wired inputs or time clock. The disable input is normally configured for N/O operation. This parameter allows its operation to be changed to N/C.



Menu 5 Output Four Setup

Menu 5. Output Four Setup

The output setup parameters in Menu 5 is used to configure Output Four.

Menu 5.1: Output Pulse Time

This parameter sets the duration of the output pulse time. The output pulse time is used only for pulse functions. The time is adjustable from 0.1 to 99.9 units.

Menu 5.2: Pulse Time Units

This parameter sets the units used for the output time settings. The options are Sec, Min or Hrs.

Menu 5.3: Flash On Time & Menu 3.4: Flash Off Time

A flash on an output is created by repeatedly turning the output on and off. The Flash On Time sets the duration of the on phase while the Flash Off Time sets the duration of the off phase. For a steady output state which does not flash, set the Flash On Time = 0.0s. The Flash Off Time is not used for steady state outputs.

Menu 5.5: Complete Flash Sequence

Turning this parameter on will allow the flash cycle to complete if the output is turned off during the flash cycle.

Menu 5.6: Output Four Inverted

Output Four is configured for N/O operation. This parameter allows its operation to be changed to N/C.

Menu 5.7: Trigger Four Input

Output Four can also be controlled via independent Trigger Four input. The trigger input can be programmed to activate its output similar to a transmitter button.

Menu 5.8: Trigger Four Input Contact

Trigger Four input is configured for N/O operation. This parameter allows its operation to be changed to N/C.

Menu 5.9: Disable Four Input Contact

This input can be used to disable the output in software regardless of the state of the transmitters, wired inputs or time clock. The disable input is normally configured for N/O operation. This parameter allows its operation to be changed to N/C.

Menu 6 Operating Modes

Menu 6.1-4 Default Tx B1-4 Functions

These parameter are used to set the default output function offered when coding a transmitter button.

Menu 6.5 Remote Code

The receiver supports the Remote Code Set feature. This parameter can be used to disable the feature for security or transmitter management reasons.

Menu 6.6 Activity Reports

This parameter enables activity report outputs. Contact Automatic Technology for more details.

Menu 6.7 Activity Report ID

This parameter sets the ID of the controller that is sent with the activity report. Contact Automatic Technology for more details.

Menu 6.8 Vacation Mode

Vacation mode can be turned on or off using this parameter.





Menu 6.9 Password Protection

The password feature enables all parameters and configuration settings to be protected unless a password is entered. When this feature is turned on, the user is requested to enter a password to be used. The password protection feature has a timeout that expires after 60 seconds of inactivity. Alternatively the User may log out manually by pressing EXIT when the main screen is displayed.

Menu 6.10 Transmitter # Grouping

The transmitter store number display format can be changed to show a grouped format. When grouping is selected, instead of displaying the store location as a number between 1 and 511, it is displayed as ##\$ where ## is the group number and \$ is a character a,b,c,d,e,f,g or h which indicates the group member.

Menu 7 Time Clock

The MegaCode® receiver provides a programmable Time Clock which can be used to control its outputs on a timed basis at various times of the week. This section details the Time Clock operation and configuration.

Time Clock Operation

The Time Clock consists of a 7 day clock and storage for 32 programs . The clock is powered by its own battery and therefore does not lose time when the MegaCode® receiver is turned off. Each Time Clock program defines the time of the day and the days of the week it is to run and the output function to be executed. Any combination of the days of the week can be selected.

The output actions available are:

- S_# Output# is SET on, Transmitter and wired triggers are ignored.
- R_# Output# is RESET off, Transmitter and wired triggers are ignored.
- RX# Output# is released for transmitter and wired trigger access. The output state is not changed.
- Not used

Note that the most recent program that applies to an output remains active until a new program takes effect. The program is not just executed at the programmed time but from the programmed time until another program takes over. This also means that each output's state is correctly restored after power failure, Vacation Mode and output disabling. If a Time Clock program does not have a day selected then it can not be executed. If a Time Clock program is taking control of an output (function = S_# or R_#), then this status is displayed on the MAIN SCREEN in the output field as #S or #R where # is the program number.

Time Clock Settings

The Time Clock settings are accessed by selecting the Time Clock Menu 7. Press SET to enter the menu and then PREV or NEXT to navigate through the options.

Menu 7.1 Set Time/date

This is where the current time, date and day are displayed and set. Note the time is in a 24 hour format and the day of the week is not automatically set with the date. To change the settings simply press UP or DOWN to display the cursor and then move to the field to be changed using the NEXT / PREV buttons. Then press UP/DOWN to change the setting and then press the SET or EXIT buttons to save.

fig 26

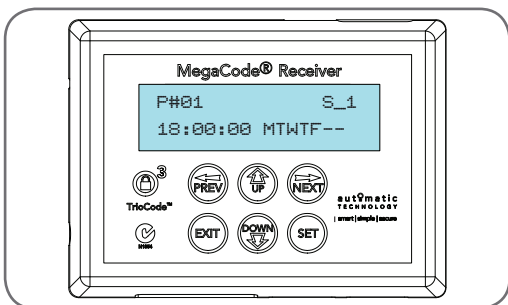

Menu 7.2 View Programs

Select this menu to display or edit the Time Clock programs. When selected, program number 1 is displayed and the cursor is shown on the program number field. The other fields shown include the function, time and days of operation. The example in Fig. 26 shows that output 1 will be SET on at 6pm on Mondays, Tuesdays, Wednesdays, Thursdays and Fridays. Use the UP / DOWN buttons to scroll through the other programs. To edit a program, simply press the NEXT / PREV buttons to move the cursor onto the required field and press the UP/DOWN button to change the value. To save the program settings, press SET or to exit without saving press EXIT.





Menu 7.3 Settings

This menu is used to adjust the Time Clock according to the daylight saving period.

Menu 7.3.1 Run Programs

This parameter allows the User to halt or run the timer programs.

Menu 7.3.2 Disable 4 Input

This input can be used as a daylight saving time adjuster. When activated, it will add the amount of time selected in Menu 7.3.4 to the Time Clock.

Menu 7.3 .3 Disable 4 Input Contact

Disable four (4) input is configured for N/O operation. This parameter allows its operation to be changed to N/C

Menu 7.3 .4 Daylight Saving Time Adjust

The amount of time to add to the time clock at start of daylight saving period is selected here. The options are: 0, 30, 90, 120 minutes

Menu 8 Diagnostic Tools

fig 27

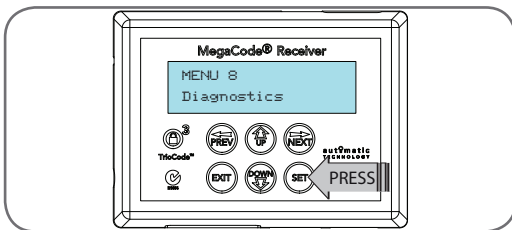

The controller provides several diagnostic tools from within the Diagnostics Menu 8. This section details the function of each tool and its use.

Navigating to Diagnostics Menu

1. Press PREV to navigate Menu 8 (Fig. 27).
2. Press SET to display the menu of available functions.
3. Press PREV or NEXT to cycle through the diagnostic tool.
4. Press SET to select.

fig 28

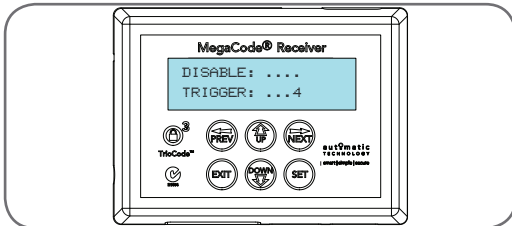

Menu 8.1 Test inputs

This tool is used to view the state of the control inputs. When selected, a screen is displayed (Fig. 28) which indicates the state of disable and trigger inputs. If the number of the input is shown then that input is active. For normal operation all inputs should be inactive when idle. When finished press EXIT. The example in Fig. 28 shows the status shown when Trigger 4 input is active.

fig 29

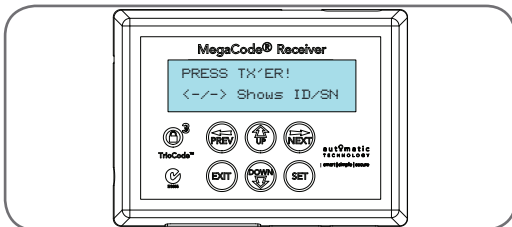

Menu 8.2 Test tx'ers

This tool is used to test receiver/transmitter functionality. When selected, a screen is displayed which prompts for a transmitter button to be pressed (Fig. 29) and whether ID or serial numbers are to be displayed.

fig 30

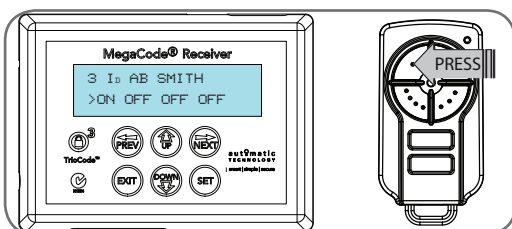

The opener will then beep each time a transmission is received. If the transmitter button is stored in the controller memory and has a function assigned to it, a second screen will be displayed that shows the transmitter details along with the button pressed (Fig. 30). The example shows the case when transmitter number 3 is activated by button 1. Note ID is selected for display.





fig 31

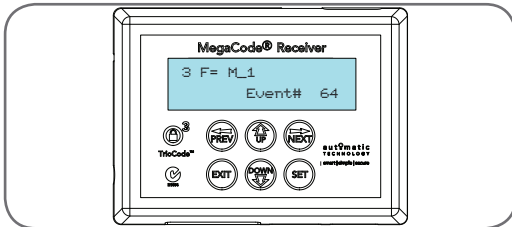

Menu 8.3 Display history

The MegaCode® keeps a record of the last 64 events that have taken place. The events include outputs turning off & on and by what cause, power failures etc. When this tool is selected, a screen displays the last event that occurred. The NEXT and PREV buttons can be used to view each event. The "EVENT#" field shows the sequence of the events, with 64 being the first and 1 being the last. The example (Fig. 31) shows that the last event was "output 1 was triggered by the transmitter # 3". When finished viewing the events, simply press EXIT.

fig 32

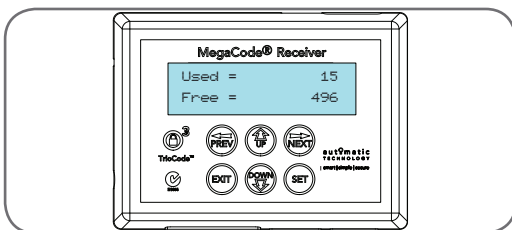

Menu 8.4 Memory usage

This tool displays the number of transmitter store location used and the number free (Fig. 32).

Menu 8.5 Console Test

This tool allows to test the console buttons and the beeper.

Menu 9 Memory Tools

fig 33

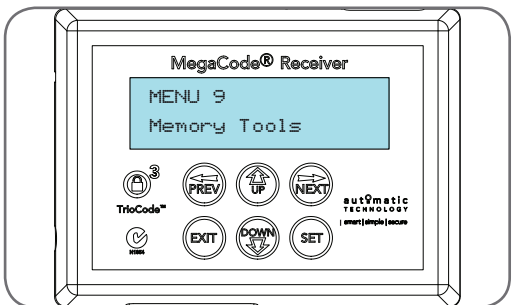

The Memory Tools accessed from within Menu 9 (Fig. 33) are used to clear the controller's memory. Once selected, the PREV or NEXT buttons can be used to view the Memory Tool options. To execute the displayed option simply press SET.

Menu 9.1 Clr control

This option will clear the MegaCode® receivers memory and reload the factory set defaults for parameters.

Menu 9.2 Clr tx'ers

This option will clear the transmitter storage memory.





Specifications

Technical Specifications

Power supply	12 - 24V AC/DC.
Number of Outputs	Four (4)
Continuous Load Current Per Output	100 mA @ 40 VAC/DC
Receiver type	TrioCode™ or Tri-Tran™ type
Receiver code storage capacity	511 X 4 button Transmitter Codes





Warranty and Exclusion of Liability

1. This warranty is an addition to any non-excludable conditions or warranties that are implied into this contract by relevant statute, including the Trade Practices Act 1974 (Cwth).
2. Subject to all of the matters set out below, Automatic Technology Australia Pty Ltd ("ATA") warrants:
 - (a) The MegaCode® receiver for twelve (12) months from the date of purchase (specified in the sales docket receipt) as free of any defects in material and workmanship.
 - (b) no further warranty will apply for goods repaired under warranty.
 - (c) for all products repaired outside the warranty period, a six months warranty applies from the date of dispatch.
3. This warranty applies only where the purchaser:
 - (a) immediately notifies ATA or the retailer of the alleged defect;
 - (b) returns the product to the retailer; and
 - (c) presents the relevant sales docket and this warranty document to the retailer to confirm the date of purchase.
4. Except for this warranty, ATA gives no warranties of any kind whatsoever (whether express or implied), in relation to the product, and all warranties of whatsoever kind relating to the product are, to the extent permissible by statute, hereby excluded.
5. To the extent permissible by statute, ATA disclaims any liability of whatsoever nature in respect of any claim or demand for loss or damage which arises out of:
 - (a) accidental damage to or normal wear and tear to the product or to the product's components;
 - (b) any cost relating to damage resulting from wear and tear;
 - (c) blown fuses, loss or damage caused by electrical surges, power surges or power spikes;
 - (d) loss or damage due to theft, fire, flood, rain, water, lightning, storms or any other acts of God;
 - (e) evidence of unauthorised repairs;
 - (f) any cost relating to damage caused by misuse, negligence or failure to maintain the equipment in a proper working order as per clauses (d) through (h);
 - (g) installation, adjustment or use which is not in accordance with the instructions set out in installation instruction manual
 - (h) attempted or complete modification or repairs to the product carried out by a person who is not authorised or has not been trained by ATA to carry out such modification or repairs;
 - (i) faulty or unsuitable wiring of structure to which the product is fixed or connected;
 - (j) radio (including citizen band transmission) or any electrical interference;
 - (k) damage caused by insects;
 - (l) loss or damage to any property whatsoever or any loss or expense whatsoever resulting or arising there from or any consequential loss;
 - (m) any cost or expense arising due to manufacturer recall of any product;
 - (n) any cost or expense due to negligence of the approved service provider;
6. ATA's liability under this warranty is limited, at ATA's absolute option, to replacing or repairing the product which ATA, in its unfettered opinion, considers to be defective either in material and/or workmanship or to credit the dealer with the price at which the product was purchased by the dealer.
7. This warranty does not extend to cover labour for installation.
8. This warranty is limited to Return-to-Base (RTB) repair and does not cover labour for on-site attendance.
9. This warranty is void if the Product is not returned to the manufacturer in original or suitably secure packaging.
10. This warranty is only applicable for repairs to the product carried out within Australia.
11. This warranty does not cover consumable items including globes, batteries and fuses.
12. This warranty is not transferable.
13. Where the Product is retailed by any person other than ATA, except for the warranty set out above, such person has no authority from ATA to give any warranty or guarantee on ATA's behalf in addition to the warranty set out above.





© July 2010 Automatic Technology (Australia) Pty Ltd. All rights reserved. TrioCode™, is a trademark and MegaCode® is a registered trademark of Automatic Technology (Australia) Pty Ltd. Tri-Tran™ is a trademark of B&D Doors No part of this document may be reproduced without prior permission. In an ongoing commitment to product quality we reserve the right to change specification without notice. E&OE.

automatic
TECHNOLOGY

smart | simple | secure

an alesco company

Automatic Technology (Australia) Pty Ltd

ABN 11 007 125 368

6-8 Fiveways Boulevard
Keysborough, Victoria, 3173, Australia

P 1300 133 944

+61 2 9722 5666 (International Enquiries Only)

E sales@ata-aust.com.au

www.ata-aust.com.au